	Component Maintenance Manual	Document Number 122-005-00	Revision 36
		Date 12/22/22	Page 1 of 35

Component Maintenance Manual, Cargo Hook

Onboard Systems International, LLC
13915 NW 3rd Court
Vancouver, WA 98685 United States of America
Cage Code: 1Y921

Toll Free Phone: (800) 275-0883
Phone: (360) 546-3072
Fax: (360) 546-3073

Applicable Equipment Part Numbers

<u>Obsolete P/Ns</u>	<u>Current P/Ns</u>
528-023-00	528-023-01
	528-023-03
	528-023-51

***Please check our web site www.onboardsystems.com
for the latest revision of this manual.***

	Component Maintenance Manual	Document Number 122-005-00	Revision 36
		Date 12/22/22	Page 2 of 35

RECORD OF REVISIONS

Revision	Date	Page(s)	Reason for Revision
23	03/12/12	17	Remove reference to “Major Repair” in para. 11.1.
24	08/16/12	7, 17, 18	Clarified applicability of Onboard Systems ATP documents. Clarified power supply requirements. Removed reference to nylon slings and added Caution regarding these. Updated definition of “hours of external load operations” for clarity.
25	10/24/12	21	Added S/N Plate, P/N 215-294-00, to Bill of Materials. Changed Serial Plate, P/N 215-191-00, to optional.
26	03/26/13	7, 8, 15, 16	Corrected item numbers.
27	10/11/13	5, 6, 8-34	Added requirement to maintain record of all cargo hook activity (pg 5). Added Storage and Inactivity section. Added Section 6.3. Added photos to sections 8 and 10 and rearranged steps for ease of assembly.
28	12/05/13	20-22	Added toggle pin installation warning.
29	03/03/14	14 & 17-35	Added Cam Bearing deburr warning.
30	05/24/17	12, 18	Removed NDT requirement for Attach Bolt and Cam Assembly. Updated section 10.8 to include O-ring assembly instruction.
31	01/19/18	12, 14	Removed NDT requirement for Solenoid Cam (13.7), Manual Release Lever (20.1) and Cam Roller Pin (23.6). Added inspection criteria for Manual Release Lever and Solenoid Cam to Table 9.1.
32	05/02/19	33	Added screw 510-755-00 to 528-023-51 configuration.
33	01/14/20	6, 12	Replaced NDT inspection of Toggle Assembly (23) and Load Beam Assembly (25) with magnified visual inspection; moved inspection step to Table 9.1. Changed item 1 of section 4.5 to require a functional check rather than full ATP.
34	04/29/21	28	Corrected the 14-volt solenoid (used in cargo hook P/N 528-023-03) current draw range from “between 3 and 5 amps” to “between 5 and 9 amps”.
35	08/10/22	5, 6, 8	Changed section 4.2 from “Monthly Preventative Maintenance” to “Cleaning and Preventative Maintenance”. In Section 4.5 – changed activity required after removal from controlled storage from full ATP to a “functional check per steps 11.7 through 11.9”. Added grace period (tolerance) to inspection calendar time/hours.
36	12/22/22	13, 16, 17, 33	Add cleaning and inspection instructions for cam surfaces. Add cam assembly to overhaul kit.

Register Your Products for Automatic Notifications

Onboard Systems offers a free notification service via fax or email for product alerts and documentation updates. By registering your Onboard Systems products at our website, we will be able to contact you if a service bulletin is issued, or if the documentation is updated.

You can choose to receive notices on an immediate, weekly, or monthly schedule via fax, email or both methods. There is no charge for this service. Please visit our website at www.onboardsystems.com/notify.php to get started.

	Component Maintenance Manual	Document Number 122-005-00	Revision 36
		Date 12/22/22	Page 3 of 35

1.0 Introduction

- 1.1 **Scope.** This component maintenance manual contains instructions for inspection, maintenance and overhaul.
- 1.2 **Capability.** The instructions contained in this document are provided for the benefit of experienced aircraft maintenance personnel and facilities that are capable of carrying out the procedures.
- 1.3 **Safety Labels.** The following definitions apply to safety labels used in this manual.



Indicates a hazardous situation which, if not avoided, will result in death or serious injury.



Indicates a hazardous situation which, if not avoided, could result in death or serious injury.



Indicates a hazardous situation which, if not avoided, could result in minor or moderate injury.



Draws the reader's attention to important or unusual information not directly related to safety.



Used to address practices not related to personal injury.

	Component Maintenance Manual	Document Number 122-005-00	Revision 36
		Date 12/22/22	Page 4 of 35

2.0 Referenced Documents

180-159-00 Acceptance Test Procedure – Cargo Hook P/N 528-023-01 and 528-023-51

180-168-00 Acceptance Test Procedure – Cargo Hook P/N 528-023-03

3.0 Service Bulletins/Amendments

3.1 The cargo hook(s) are subject to the following service bulletin(s). Service bulletin documents may be obtained from the Onboard Systems web site. Verify compliance with all service bulletins prior to maintenance. If in possession of a cargo hook with an unincorporated service bulletin, please contact the factory for additional guidance.

Service Bulletin	Description	P/N Applicability	S/N Applicability
159-011-00	Spring upgrade. P/N 528-023-00 was changed to 528-023-01. This change incorporated Spring Assembly 514-056-00 and Spring Retainer 290-819-00.	528-023-00	All

3.2 Cargo hook P/N 528-023-51 incorporates the following amendment(s).

Amdt.	Description of Amendment
A	Replaced bolt P/N 510-373-00 with P/N 290-913-00. Replaced bolt P/N 510-374-00 with P/N 290-914-00.

	Component Maintenance Manual	Document Number 122-005-00	Revision 36
		Date 12/22/22	Page 5 of 35

4.0 Maintenance

- 4.1 Maintain a record of ALL cargo hook activities including aircraft installation and removal, inspections, repair and overhaul as well as inactivity and storage events.



Failure to follow all equipment maintenance instructions and component inspection criteria may result in serious injury, death or immediate loss of flight safety.

4.2 Cleaning and Preventative Maintenance

1. As needed per visual condition remove accumulated soils from exterior with a soft bristle brush and mild solvent/cleaner.
2. As needed per visual condition, in salt water environments, apply a corrosion preventative compound such as ACF-50 to all exterior surfaces.

4.3 Annual Inspection

1. Annually or 100 hours of external load operations, whichever comes first, remove the Cargo Hook from the aircraft. Thoroughly clean the exterior with a soft bristle brush and mild solvent/cleaner and visually inspect for cracks, gouges, dents, nicks, corrosion, and missing or loose fasteners. If damage is observed, refer to Table 9.1 for acceptance criteria.

A one-month or 10-hour grace period can be applied if needed. No additional extension is allowed beyond this grace period.

2. Lubricate the Cargo Hook Attach Bolt. Recommended lubricants are Mobilgrease 28 or AeroShell 7.

4.4 Overhaul

1. Overhaul the Cargo Hook in accordance with the overhaul schedule and instructions contained here-in.

	Component Maintenance Manual	Document Number 122-005-00	Revision 36
		Date 12/22/22	Page 6 of 35

4.5 Storage and Inactivity

1. The cargo hook may be stored in its original factory sealed bag and box for up to 2 years from its date of manufacture or last factory overhaul. If stored in its original factory sealed bag and box for less than 2 years, it may be used without any additional activity. If the period of storage in its original packaging is greater than 2 years the cargo hook must be subjected to a functional check before being used. Perform the functional check per instructions of sections 10.7 through 10.9 of the acceptance test procedures (ATP) described herein.

2. If the cargo hook has been installed on an aircraft and subsequently removed from service, store it in a reasonably protected indoor, dry, heated storage area for up to 6 months. If stored in this condition for less than 6 months, it may be used without any additional activity. If it is to be stored longer than 6 months perform the following activities. Prepare the cargo hook for storage by thoroughly cleaning and drying the exterior, liberally applying ACF-50 corrosion preventative compound inside and out, sealing it in a plastic bag with a desiccant, and labeling it with the date of storage. If stored in this condition for less than 2 years, it may be placed in service without any additional activity.

If the period of storage exceeds 2 years the cargo hook must be subjected to a functional check before being used. Perform the functional check by completing steps 11.7 through 11.9 of the acceptance test procedures (ATP) described herein before being used. Note: the 5-year overhaul schedule applies regardless of storage or inactivity periods (reference section 6.0).

3. If the cargo hook has been installed on the aircraft and subsequently removed from service but not stored in accordance with the instructions above, the cargo hook must be subject to the ATP described herein before being placed in service.

4.6 Repair

1. Repair the Cargo Hook in accordance with the repair instructions contained here-in.

	Component Maintenance Manual	Document Number 122-005-00	Revision 36
		Date 12/22/22	Page 7 of 35

5.0 Repair Instructions

- 5.1 It is recommended that only minor repairs be attempted by anyone other than the factory. The following procedures and information are provided for the benefit of experienced aircraft maintenance facilities capable of carrying out the procedures. They must not be attempted by those lacking the necessary expertise and suitable equipment to acceptance test the cargo hook after maintenance. See Section 14 for instructions for returning equipment to the factory.
- 5.2 Follow these steps to repair the Cargo Hook, referring to the applicable sections in this manual:
1. Disassemble as required.
 2. Inspect disassembled parts.
 3. Obtain required replacement parts.
 4. Re-assemble.
 5. Acceptance test.
 6. Inspect for return to service.

	<h2>Component Maintenance Manual</h2>	Document Number 122-005-00	Revision 36
		Date 12/22/22	Page 8 of 35

6.0 Overhaul Schedule

- 6.1 The Cargo Hook shall be overhauled every 1000 hours of external load operations or 5 years, whichever comes first. A six-month or 100-hour grace period can be applied if needed. No extension to this interval is allowed beyond this tolerance grace period.
- 6.2 Hours of external load operations should be interpreted to be (1) anything is attached to the cargo hook (whether or not a useful load is being transported) and (2) the aircraft is flying. If these conditions are NOT met, time does NOT need to be tracked.
- 6.3 The 5-year period is from the initial installation date when the cargo hook is new or newly overhauled, regardless of storage or inactivity periods. If initial installation date is unknown, then 5-year period is from date of manufacture as indicated on the cargo hook data plate or 5 years from date of last overhaul indicated on the overhaul sticker.

7.0 Overhaul Instructions

- 7.1 It is recommended that only minor repairs be attempted by anyone other than the factory. The following procedures and information are provided for the benefit of experienced aircraft maintenance facilities capable of carrying out the procedures. They must not be attempted by those lacking the necessary expertise and suitable equipment to acceptance test the cargo hook after maintenance. See Section 14 for instructions for returning equipment to the factory.
- 7.2 Overhaul kit P/N 212-015-00 is recommended to complete the Cargo Hook overhaul. The overhaul kit contains all recommended items to be replaced at time of overhaul. Table 13.1 lists detail parts contained in the overhaul kit.
- 7.3 Follow these steps to overhaul the Cargo Hook, referring to the applicable sections in this manual:
1. Obtain Overhaul kit P/N 212-015-00.
 2. Completely disassemble.
 3. Discard all items that are to be replaced by an item in Overhaul Kit P/N 212-015-00 listed in table 13.1 (springs, bearings, roll pins, cotter pins, fasteners except Attach Bolt (5), nuts and washers).
 4. Inspect disassembled parts.
 5. Obtain required replacement parts.
 6. Reassemble.
 7. Acceptance test.
 8. Inspect for return to service.

8.0 Disassembly Instructions

- 8.1 Cut and remove all safety wire.
- 8.2 Remove manual release cover (7) by removing two screws (6).
- 8.3 Remove cotter pins (1, 8)
- 8.4 Remove solenoid assembly (13) by removing nuts (9, 11), and washers (10, 12) from frame bolts (14, 15).
- 8.5 Remove nut (11) from frame bolt (16).
- 8.6 Remove nut (29), and washer (19) from frame bolt (28). Remove manual release lever (20) and spring retainer (30). Carefully remove spring (21).

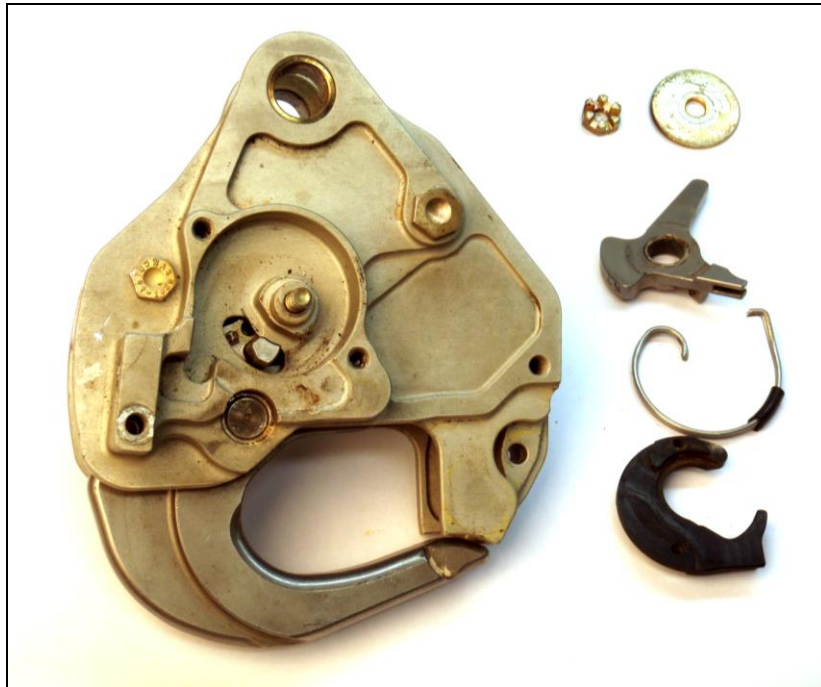

- 8.7 The frame can now be split by lifting the side plate (22.1) from the assembly. The internal mechanism can now be viewed and cycled to check for smooth operation. All of the internal parts may be removed at this time.

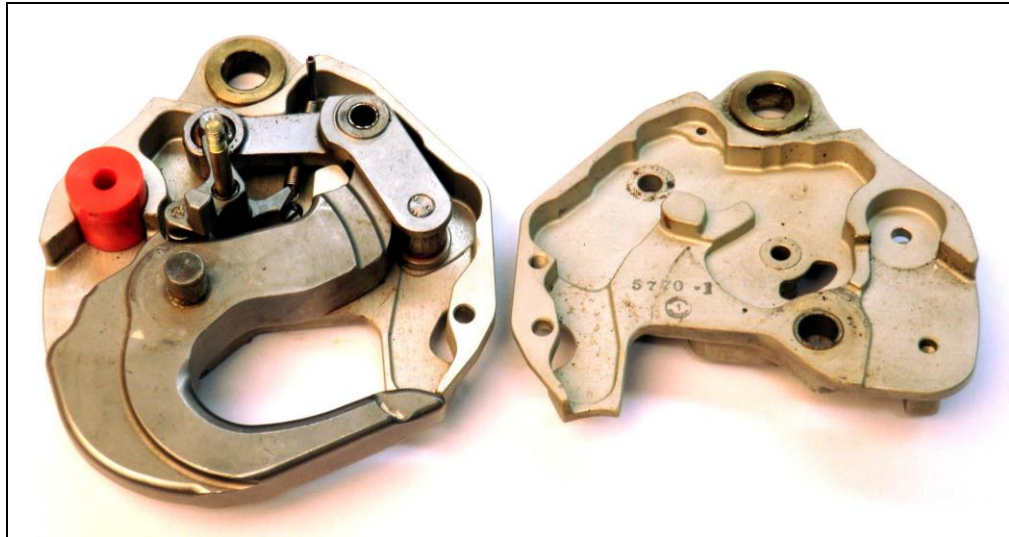

- 8.8 The solenoid (13.4) may be removed from the cover (13.3) by removing two nuts (13.1) and two washers (13.2). Note the orientation of connector (13.8), diode (13.9) and solenoid wires. Do not typically unsolder the wires at the connector (13.8) and diode (13.9). Note the orientation of solenoid cam (13.7) and remove three screws (13.6).

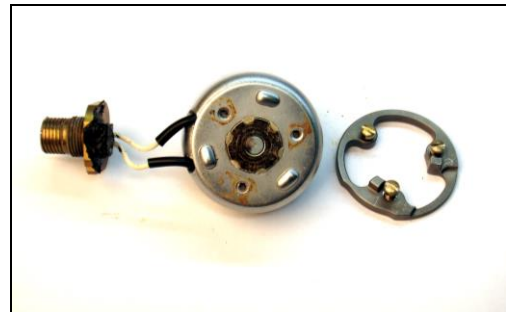
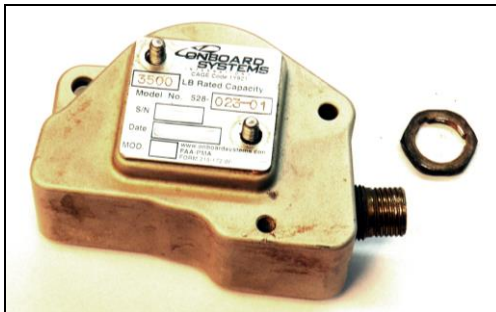

- 8.9 Remove the attach bushings (22.2, 27.2) by pressing them out of the side plates.
- 8.10 Bushings and bearings may be removed from detail parts by conventional means.

- 8.11 Do not typically disassemble the bushings, roller, and pin (24.3, 24.4, 24.5) from the cam assembly (24).



- 8.12 Do not typically disassemble the bushings, roller, and pin (23.2, 23.3, 23.4) from the toggle assembly (23).

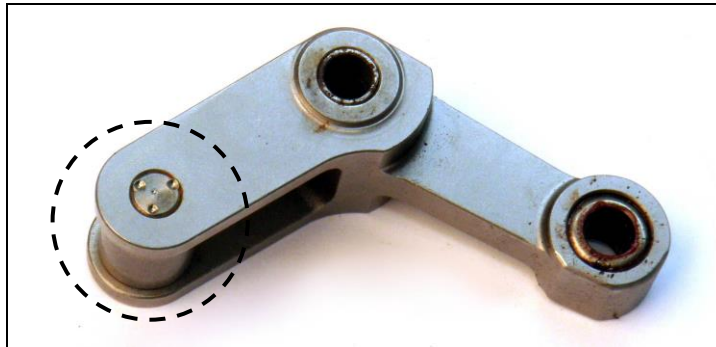

- 8.13 Do not typically disassemble the load beam (25.1) from the load beam shaft (25.2).

	Component Maintenance Manual	Document Number 122-005-00	Revision 36
		Date 12/22/22	Page 12 of 35

9.0 Inspection Instructions

- 9.1 Thoroughly clean all parts to be inspected using standard methods. Parts should be completely free of surface contaminants, soils or grease before beginning inspections.
- 9.2 If the Cargo Hook is being overhauled, perform nondestructive inspection on the parts below to confirm absence of cracks which may have developed in service. Confirmed cracks of any size are cause for part replacement.

For the **Side Plate, Solenoid (27.1)** and **Side Plate, Manual Release (22.1)**, inspect using:

- Liquid penetrant inspection per ASTM E1417

Mark all indications from penetrant inspection then interpret each under 10X magnification. Differentiate surface cracks from other non-relevant indications such as machine tool marks, scratches, dents or superficial corrosion.

- 9.3 Carefully inspect detail parts in accordance with the instructions in Table 9.1. Inspect the parts in a clean, well lighted room using standard dimensional measuring tools and visual methods. Repair parts found within inspection limits. Replace any part found beyond limits.

Table 9.1, Cargo Hook Inspection Criteria

Seq	Component	Inspection Criteria & Limit	Repair Action	Finish	Recommended replacement at Overhaul
1.	Load Beam Assembly (25), Toggle Assembly (23)	Surface cracks – inspect under illuminated magnification (minimum 2X / 4 diopter).	None. Cracks of any size are cause for part replacement.	N/A	No
2.	Attach bolt (5) Load Beam Assy (25) Manual Release Lever (20.1) Solenoid Cam (13.7) Armor Plate (17, 18)	Corrosion – 0.006 in. (0.127 mm) deep	Glass bead blast at less than 30 PSI (2.11 KGF/CM ²) to remove corrosion.	Passivate per AMS-QQ-P-35 or ASTM A967	No
3.	Side Plate (22.1, 27.1)	See figure 9.1	Blend at 10:1 ratio as required to provide smooth transitions.	Apply alodine (MIL-DTL-5541) and zinc chromate primer (MIL-PRF-23377 or similar) to affected surfaces – see Note 1	No



Component Maintenance Manual

Document Number
122-005-00

Revision
36

Date
12/22/22

Page
13 of 35

Seq	Component	Inspection Criteria & Limit	Repair Action	Finish	Recommended replacement at Overhaul
4.	Side Plate (22.1, 27.1)	Wear or deformation of top attach bushing, hole ID – 0.6264 in (15.91 mm)	None	N/A	No
5.	Manual Rel. Cover (7) Solenoid Cover (13.3)	Dents, nicks, cracks, gouges, scratches and corrosion – 0.020 in. (0.50 mm) deep	Blend at 10:1 ratio as required to provide smooth transitions.	Apply alodine (MIL-DTL-5541) and zinc chromate primer (MIL-PRF-23377 or similar) to affected surfaces – see Note 1.	No
6.	Attach bolt (5)	Wear on OD – 0.495 in. (12.57 mm)	None	N/A	No
7.	DU Bearing (20.2, 22.3, 23.2, 24.2, 27.3)	Wear – more than 50% copper showing	None	N/A	Yes
8.	Bearing (23.5)	Roughness, binding, looseness, or corrosion	None	N/A	Yes
9.	Attach Bushing (22.2, 27.2)	Wear on ID – 0.520 in (13.208 mm)	None	N/A	Yes
10.	Bumper (26)	Denting, cuts or abrasions – 0.060 in. (1.27 mm) deep	None	N/A	Yes
11.	Armor Plate (17, 18)	Gouges and nicks – 0.050 in. (1.27 mm) deep	Blend at 10:1 ratio as required to provide smooth transitions.	Passivate per AMS-QQ-P-35 or ASTM A967	No
12.	Cam Assembly (24)	See Figure 9.2	None	N/A	Yes
13.	Cam Assembly (24)	Roughness, binding or looseness of the Interlock Roller (24.4)	Replace Interlock Pin (24.5), Roller (24.4), and Bearings (24.3)	N/A	Yes
14.	Toggle Assembly (23)	Roughness, binding or looseness of the Load Beam Roller (23.4)	Replace Pin (23.3), Roller (23.4), and Bearings (23.2)	N/A	No
15.	Manual Release Lever (20.1)	Deformation or damage at fork fitting	None	N/A	No
16.	Solenoid Cam (13.7)	Any measurable wear to cam surfaces	None	N/A	No
17.	Cam roller pin (23.6)	Any visible denting, corrosion	None	N/A	No



Component Maintenance Manual

Document Number
122-005-00

Revision
36

Date
12/22/22

Page
14 of 35

Seq	Component	Inspection Criteria & Limit	Repair Action	Finish	Recommended replacement at Overhaul
18.	Load Beam (25.1)	Wear, gouges and nicks – 0.050 in. (1.27 mm) deep	Blend at 10:1 ratio as required to provide smooth transitions and ensure load rings will not hang up during release.	Passivate per AMS-QQ-P-35 or ASTM A967	No
19.	Serial number Plate (13.10)	Damaged or illegible	None	N/A	No
20.	Solenoid (13.4)	Shorted or open electrical circuit. For Cargo Hook P/N 528-023-03, resistance 1.2 to 1.6 ohms. Other Cargo Hook P/Ns, resistance 3.0 to 4.0 ohms.	None	N/A	No
21.	Electrical connector (13.8)	Loose, missing, or mutilated contact pins, cracked case, or worn insulator	None	N/A	No
22.	Rigging warning decal (32)	Damage or illegible	None	N/A	Yes
23.	Spring (21)	Cracks or deformation	None	N/A	Yes
24.	Electrical wiring	Deterioration	None	N/A	No
25.	All remaining nuts, bolts, roll pins, cotter pins, washers, heli-coils	Wear, corrosion or deterioration	None	N/A	Yes

Note 1 – For service at Onboard Systems, optional finish: black anodize per MIL-A-8625 Type II, Class 2 after nondestructive inspection. Prepare for anodize by using standard methods.

Figure 9.1, Side Plate, Additional Inspection Criteria

Side Plate, Manual (22.1)

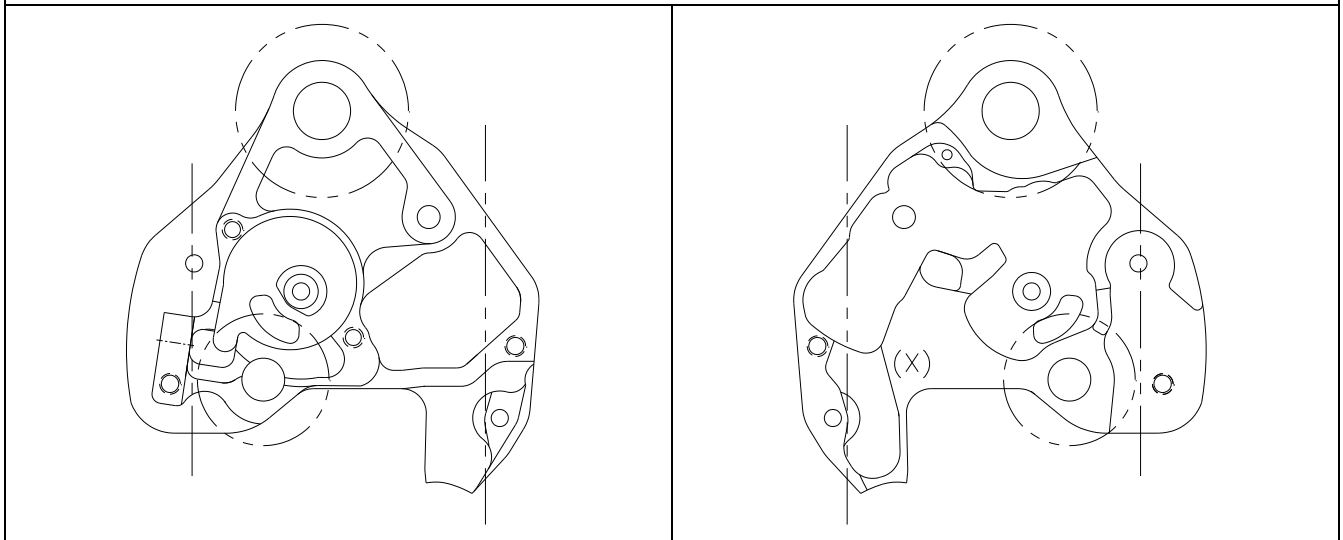

Side Plate, Solenoid (27.1)

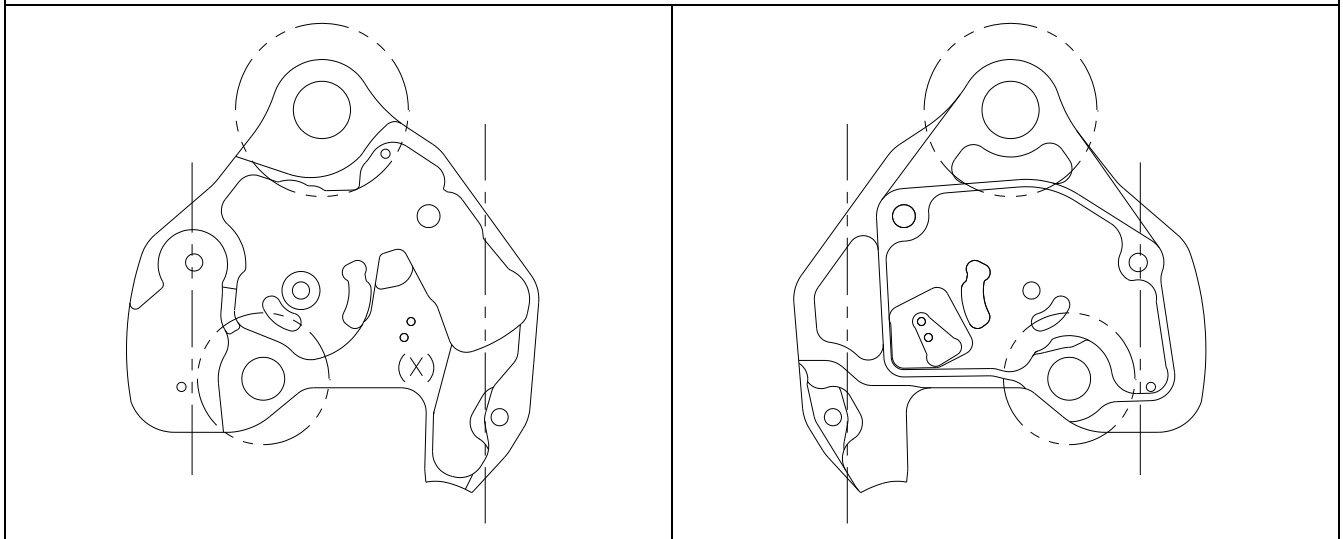

Inspection Criteria and Limits

Inside dashed circles – NO corrosion allowed.

Inside dashed circles – Dents, nicks, gouges, and scratches – 0.005 in (0.13 mm) deep.

Inside dashed lines – Dents, nicks, gouges, scratches, and corrosion – 0.010 in (0.25 mm) deep.

Outside dashed lines – Dents, nicks, gouges, scratches, and corrosion – 0.020 in (0.50 mm) deep.

(X) Approved metal stamp locations

Figure 9.2 Cam Assembly (24) Inspection Criteria

! WARNING

Thoroughly inspect surfaces inside lines for signs of visible wear, dents, corrosion, gouges or nicks. Continued use of a damaged cam may cause inadvertent load release.

! WARNING

Repair (including filing, deburring and buffing) is prohibited on all surfaces shown inside lines. Alterations of these surfaces may cause inadvertent load release.

Figure 9.2.1

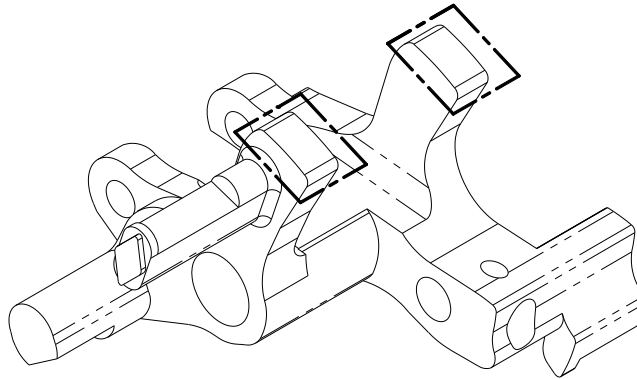
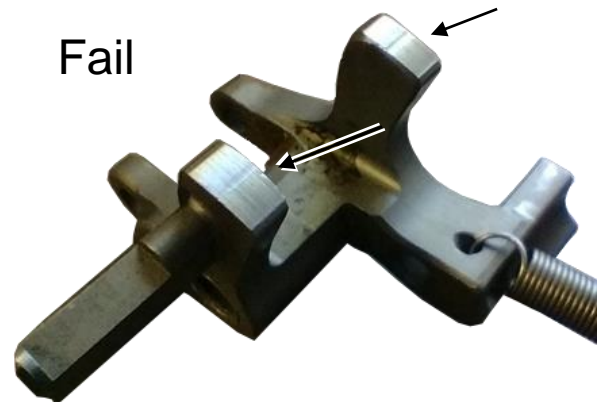

Figure 9.2.2

Pass



Fail



Continued on next page.

Figure 9.2.3

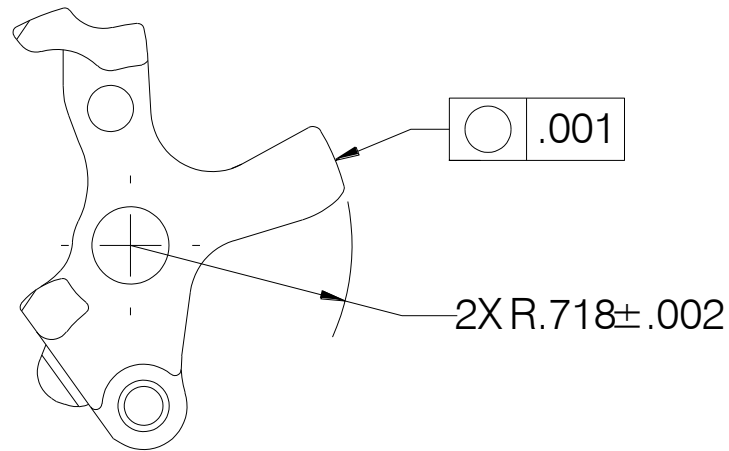

Inspection Criteria and Limits

Inside lines, see figure 9.2.1, gently clean surface by hand using Scotch-Brite (MFG: 3M, MFG P/N: 7447).
Visually inspect surface. No dents, corrosion, gouges, or nicks may remain after cleaning, see figure 9.2.2.
If the cam passes visual inspection, dimensionally inspect per figure 9.2.3.

	Component Maintenance Manual	Document Number 122-005-00	Revision 36
		Date 12/22/22	Page 18 of 35

Re-assembly Instructions

- 9.4 Replace all parts found to be unserviceable or beyond limits.
- 9.5 Measure the top attach bushing hole of side plates (22.1) and (27.1) with a bore gage to determine if the standard attach bushing (22.2, 27.2) is appropriate or if an oversize attach bushing P/N 290-294-01 is required. The oversize attach bushing P/N 290-294-01 may be distinguished from the standard attach bushing (22.2, 27.2) by the presence of a groove on the OD.

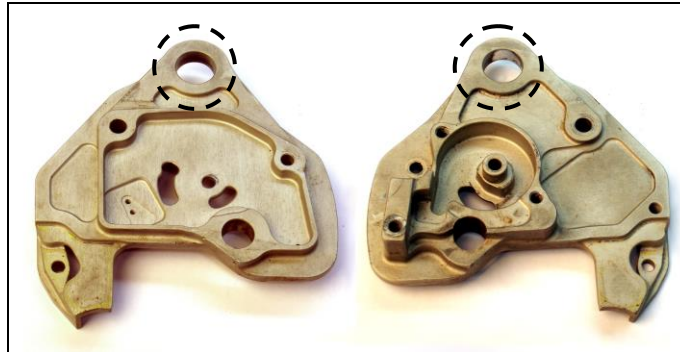

- 9.6 Install correct attach bushing into side plates (22.1) and (27.1) as follows.

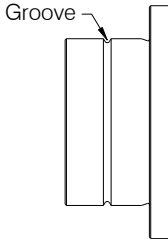
If top attach hole measures:	Use attach bushing:	Installation
Less than .6257 in (15.893 mm) .6264 - .6270 in (15.910 - 15.926 mm)	P/N 290-294-00 (22.2, 27.2) P/N 290-294-01* * Oversized Attach Bushing P/N 290-294-01 is identified by a groove on its OD as shown. 	Install with wet zinc chromate primer using an arbor press. Ensure a continuous fillet seal of primer around bushing flange after installation.
.6257 - .6263 in (15.893 - 15.908 mm) .6271 - .6285 in (15.928 - 15.954 mm)	P/N 290-294-00 (22.2, 27.2) P/N 290-294-01	Install with Loctite 680 adhesive using an arbor press. Ensure a continuous fillet seal of adhesive around bushing flange after installation.

- 9.7 Install bearings (22.3, 27.3) and roll pin (27.4) with an arbor press into side plates (22.1) and (27.1).
- 9.8 Install toggle bearings (23.2, 23.5). Use AeroShell 7 (MIL-PRF-23827) grease on the toggle cam roller bearing (23.5). If load beam roller (23.4) was removed and disassembled from toggle, press bearings (23.2) into roller (23.4) and press pin (23.3) through toggle and roller, press pin into toggle from the side shown in Figure 13.1. Stake pin into toggle holes.
- 9.9 Install cam bearings (24.2). If cam was disassembled, press bearings (24.3) into interlock roller (24.4) and press pin (24.5) through cam and roller. Stake pin into cam body. Attach spring (24.6) to cam.
- 9.10 Install solenoid cam (13.7) onto solenoid (13.4) with three screws (13.6) and safety wire. Push down on the safety wire so that it is approximately .125 inches from the solenoid.

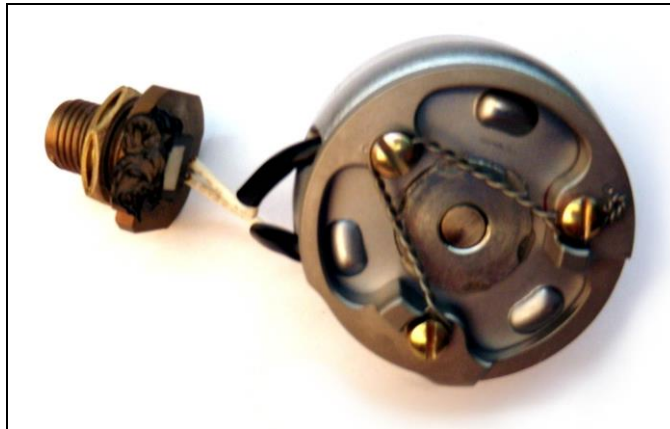

- 9.11 Install O-ring over connector (13.8) and position in groove. Install solenoid (13.4) and connector into solenoid cover (13.3) with S/N plate (13.10). Apply silicone sealant to studs and install washers (13.2) and nuts (13.1). Torque nuts to 20-25 in-lbs. plus drag torque.
- 9.12 Orient connector with notch opposite S/N plate and snug connector nut (13.8).



	Component Maintenance Manual	Document Number 122-005-00	Revision 36
		Date 12/22/22	Page 20 of 35

- 9.13 Install bolt (28) through side plate (27.1).

NOTICE

For P/N 528-023-51 amdt.0 (zero) hooks, if the toggle pivot and cam pivot bushings are being replaced, P/N 510-373-00 must be replaced with P/N 290-913-00 (item 15) and P/N 510-374-00 must be replaced with P/N 290-914-00 (item 28). Stamp an "a" in the amdt box of the S/N plate to indicate compliance.

- 9.14 Install cam assembly (24) over bolt (28) in side plate (27.1). Install spring (24.6) over roll pin (27.4).



- 9.15 Install load beam assembly (25) in Side Plate (27.1). Turn cam clockwise and insert the load beam assembly shaft into its bearing.

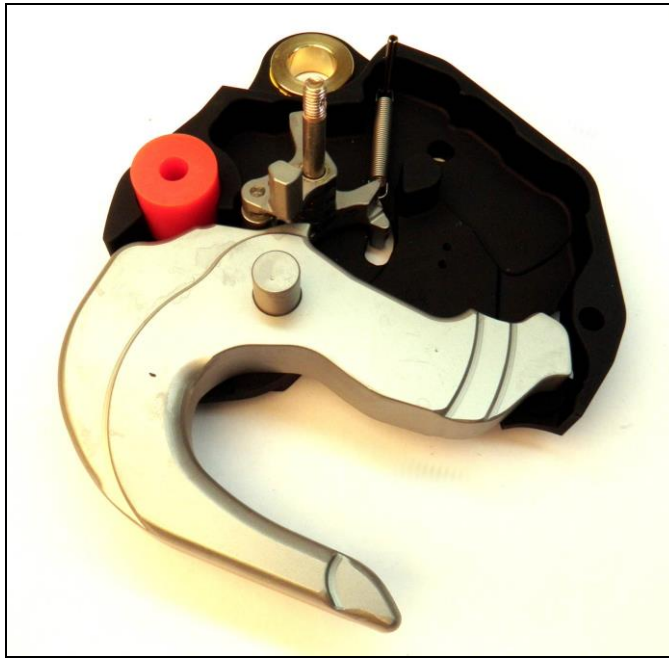

- 9.16 Install bumper (26).

	Component Maintenance Manual	Document Number 122-005-00	Revision 36
		Date 12/22/22	Page 22 of 35

- 9.17 Position toggle assembly (23) on Side Plate (27.1), apply grease to pin (23.6) and insert into toggle assembly (23) bearing.



Ensure that pin (23.6) is installed in the toggle assembly, omitting installation of pin will cause cargo hook to not function properly and be damaged.



- 9.18 Check for and remove FOD if present.
- 9.19 Align holes and set side plate (22.1) in place over assembly.

- 9.20 Push bolts (14 and 15) into place through side plate to hold internal components in place for assembly.



- 9.21 Install armor plates (17, 18) with bolt (16) and nut (11). Use corrosion preventative compound between armor plates and side plates. Torque nut (11) to 20-25 in-lbs plus drag torque.

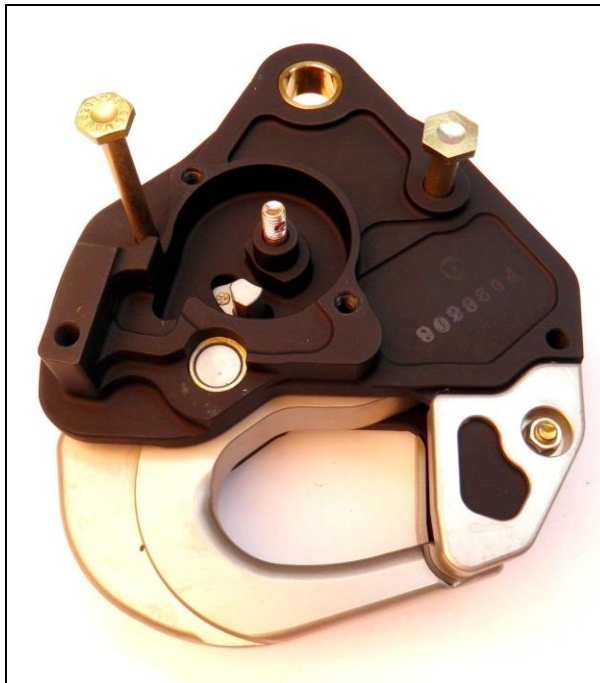

- 9.22 Check for and remove FOD if present.
- 9.23 Install spring (21) into side plate (22.1). Pull spring leg down within spring cavity to pre-load.

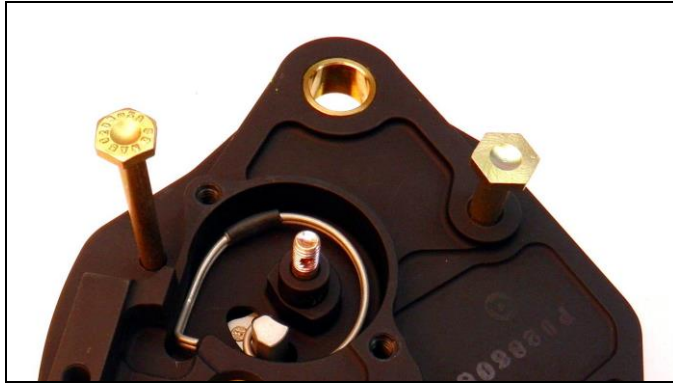

- 9.24 Install spring retainer (30). If spring retainer doesn't drop in, ensure spring leg has been pushed down far enough.

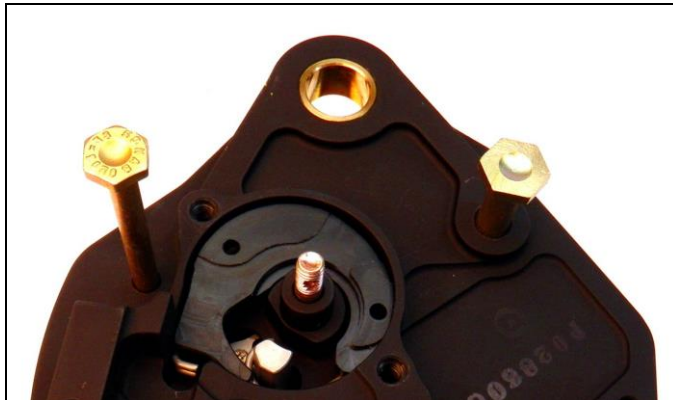

- 9.25 Install bearing (20.2) into manual release lever (20.1).
- 9.26 Place manual release lever (20.1) over the bolt (28) and side plate hub.

- 9.27 Install washer (19) and nut (29) over bolt and tighten nut finger tight, then rotate to next castellation to install cotter pin (8). Ensure washer can still freely rotate.



- 9.28 Install solenoid assembly (13) over bolts (14 and 15) and flush to side plate (27.1).

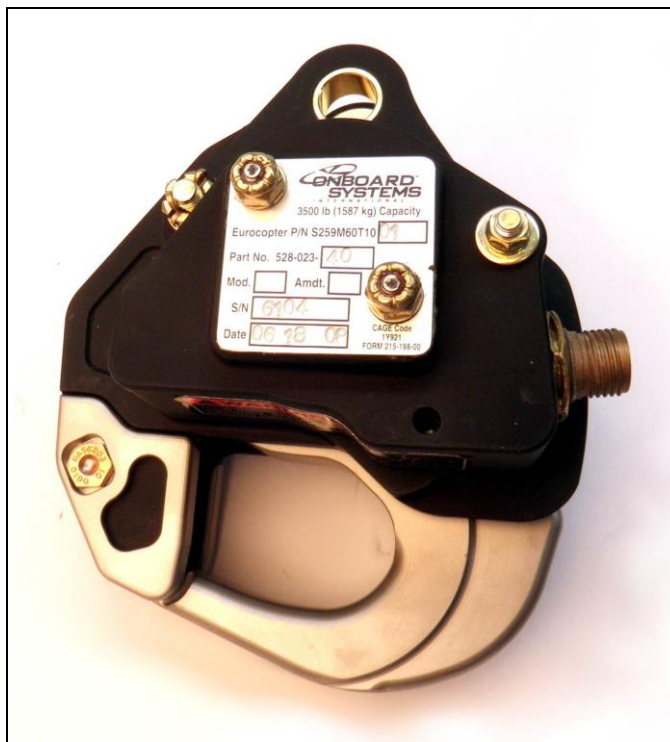

- 9.29 Install washers (10) and (12) and nuts (9) and (11)
- 9.30 Torque nut (9) to 15 in-lbs. then align hole with castle and install cotter pin (8).
- 9.31 Torque nut (11) to 20-25 in-lbs.

- 9.32 Install screw (31) and safety wire to connector nut (13.8). Cover safety wire with heat shrink tubing.



- 9.33 Install manual release cover (7) with two screws (6). Do not tighten screws. This cover will be removed and re-installed during the ATP.
- 9.34 Install attach bolt (5), washers (4), washer (3), nut (2). Temporarily install cotter pin (1).



	Component Maintenance Manual	Document Number 122-005-00	Revision 36
		Date 12/22/22	Page 27 of 35

9.35 Install rigging warning decal (32) onto bottom of solenoid cover (13.3).



9.36 If applicable, complete and install Overhaul Label 215-260-00.

9.37 Perform the acceptance test procedure per this manual.

	Component Maintenance Manual	Document Number 122-005-00	Revision 36
		Date 12/22/22	Page 28 of 35

10.0 Acceptance Test Procedure

- 10.1 When the Cargo Hook is overhauled or the side plates (22.1 and 27.1) are separated, the Cargo Hook must be subjected to the following acceptance test procedure (ATP) before being returned to service.
- 10.2 Examine the cargo hook externally for security of the lock wire, cotter pins and fasteners.
- 10.3 Use an appropriate insulation resistance tester to test the resistance between each pin and the base of the connector (13.8). The readings should not be less than 2 mega-ohms.
- 10.4 Using a multi-meter, check the resistance between pins A and B of the electrical connector. Resistance should be:

Applicable P/Ns	Resistance
528-023-01, 528-023-51	3 – 4 ohms
528-023-03	1.2 – 1.6 ohms

- 10.5 Remove the Manual Release Cover (7) and screws (6) and install a manual release test cable. Replace the Manual Release Cover and screws.
- 10.6 Suspend the hook from a test rig capable of loading the cargo hook to 8,750 pounds (3,968 KG). Use a steel ring to apply the load to the load beam.
- 10.7 Connect a power supply (see below for required VDC output) with a momentary release switch wired into the positive wire, to the connector (13.8), and an in-line current meter. Connect the negative lead to pin A and the positive lead to pin B. Set the voltage as follows:

Applicable P/Ns	Voltage
528-023-01, 528-023-51	20 VDC \pm 0.1
528-023-03	10.25 VDC \pm 0.1

- 10.8 With no load on the load beam, rotate the manual release lever clockwise. The load beam should fall open and stay in the open position. Push the load beam up and closed. The load beam should automatically latch. Repeat step.
- 10.9 With no load on the load beam, release the cargo hook with the electrical release. The load beam should fall open and stay in the open position. Push the load beam up and closed. The load beam should automatically latch. Repeat step.

CAUTION

Damage to the cargo hook release solenoid can occur if the release switch is operated for more than 20 seconds continuously.

	Component Maintenance Manual	Document Number 122-005-00	Revision 36
		Date 12/22/22	Page 29 of 35

- 10.10 Load a suitable load ring onto the load beam (25.1) and push up load beam until it latches. Gradually proof load the cargo hook with the test rig to 8,750 pounds (3968 KG). Hold the load for 1 minute. The load beam should hold the load without unlatching. Reduce the load to zero.



Do not release the proof test load electrically or manually. Decrease the load gradually, using the test machine, after completion of the proof load test.

- 10.11 Load the cargo hook using a steel ring that is free to drop clear of the load beam. Gradually load the cargo hook to 3,500 pounds (1587 KG). Using a spring scale or equivalent, pull the manual release cable. The load beam should unlatch and the steel ring should slide off the load beam. Verify the required release force is between 3.5 pounds (15.6 N) and 8 pounds (35.6 N). Repeat the test at 2000 pounds (907 KG), and 600 pounds (272 KG).



Use of a nylon sling is not recommended for load release tests as recoil may cause damage to the cargo hook.

- 10.12 Set the voltage to 20 VDC. Load the cargo hook using a steel ring that is free to drop clear of the load beam. Gradually load the cargo hook to 3,500 pounds (1587 KG). Press the electrical release button. The load beam should unlatch and the steel ring should slide off the load beam. Verify that the current draw is between 5 and 9 amps. Repeat the test at 2000 pounds (907 KG), and 600 pounds (272 KG).
- 10.13 For Cargo Hook P/N 528-023-03, set the power supply voltage to 10.25 VDC \pm 0.1. Gradually load the cargo hook to 3,500 pounds (1587 KG) and then release the load electrically. The load beam should unlatch and the steel ring should slide off the load beam. Verify that the current draw is between 5 and 9 amps. Repeat the test at 2,000 pounds (907 KG) and 600 pounds (272 KG).
- 10.14 Remove the Cargo Hook from the test stand. Remove the manual release cable and replace the Manual Release Cover (7) and screws (6).
- 10.15 End of Acceptance Test Procedure.
- 10.16 For service at Onboard Systems, optionally use the following Onboard Systems factory acceptance test procedures:

Acceptance Test Procedure	Applicable P/Ns
180-159-00	528-023-01, 528-023-51
180-168-00	528-023-03

	Component Maintenance Manual	Document Number 122-005-00	Revision 36
		Date 12/22/22	Page 30 of 35

11.0 Troubleshooting

- 11.1 The following section lists symptoms and probable causes to aid in equipment troubleshooting.

Symptom	Probable Cause	Remedy
Failure to operate electrically	Damaged or defective diode (13.9) or solenoid (13.4)	Check for proper resistance across connector pins A and B per section 11.4. If out of tolerance, remove the Solenoid Assembly (13) and disconnect the diode (13.9). Re-check for proper resistance. Replace diode (13.9) or solenoid (13.4) as necessary.
	Damaged or loose wiring	Check for proper continuity across connector pins A and B per table 9.1 seq. 16. Remove the Solenoid Assembly (13) and repair wiring.
During the Acceptance Test Procedure, the manual release cable force exceeds requirements	Friction in internal mechanism	Check operation of unit using the manual release lever. Disassemble and inspect internal mechanism. Check all bearing joints for free movement. Check cam assembly (24) for denting/damage. Check toggle roller and pin for denting/damage. Replace as necessary.

12.0 Illustrated Parts List

Figure 13.1, Cargo Hook Parts

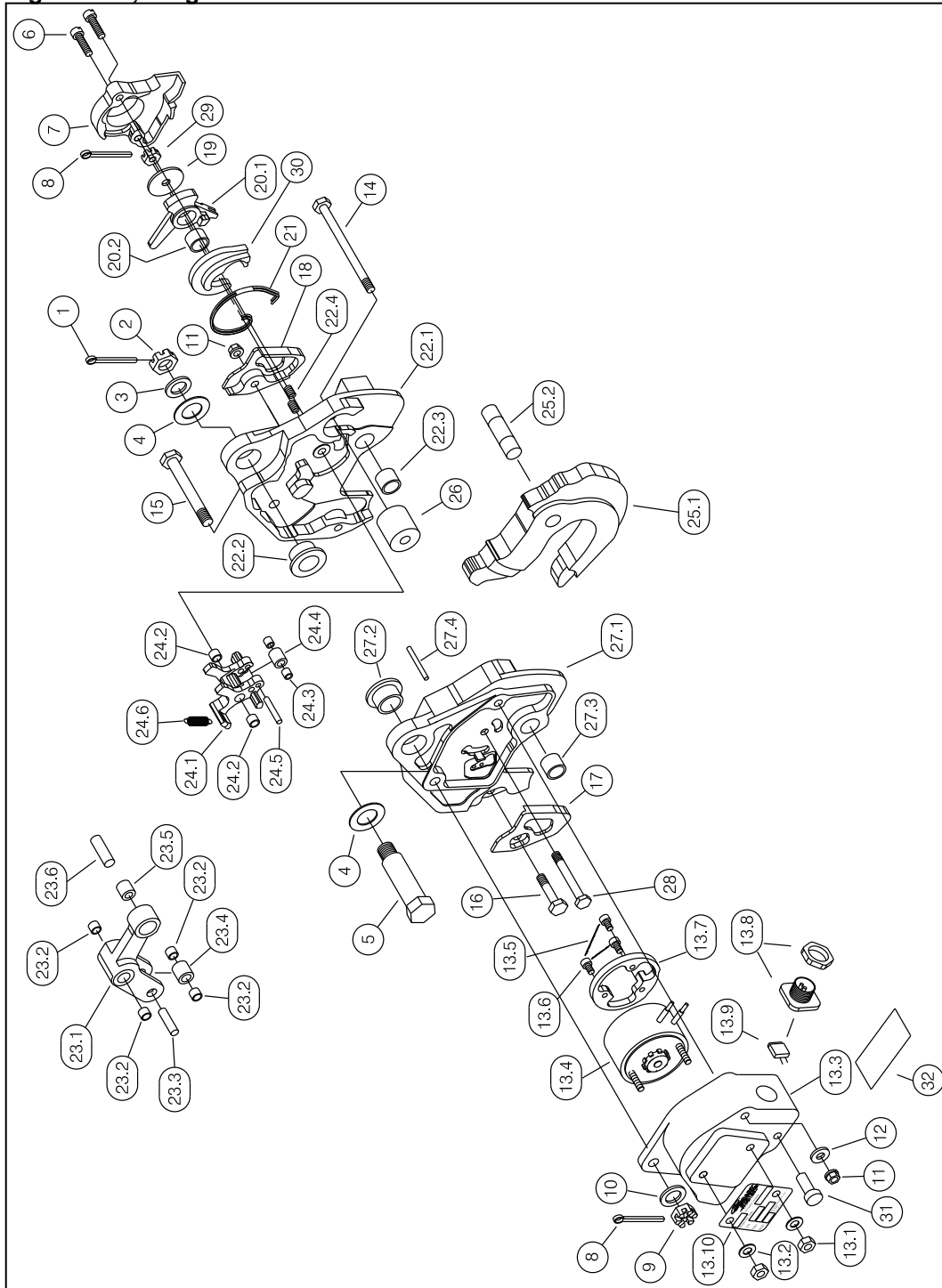



Component Maintenance Manual

Document Number
122-005-00

Revision
36

Date
12/22/22

Page
32 of 35

Table 13.1, Cargo Hook Parts

Item	Part No.	Description	Quantity in 528-023-			Included in Overhaul Kit P/N 212-015-00
			01	03	51	
1	510-178-00	Cotter Pin	1	1	1	1
2	510-170-00	Nut	1	1	1	1
3	510-174-00	Washer	1	1	1	1
4	510-183-00	Washer	2	2	2	2
5	290-332-00	Attach Bolt	1	1	1	-
6	510-377-00	Screw	2	2	2	2
7	290-646-00	Manual Release Cover	1	1	1	-
8	510-115-00	Cotter Pin	2	2	2	2
9	510-259-00	Nut	1	1	1	1
10	510-219-00	Washer	1	1	1	1
11	510-102-00	Nut	2	2	2	2
12	510-042-00	Washer	1	1	1	1
13 ¹	232-118-00	Solenoid Assembly	-	-	1	-
13 ¹	232-118-01	Solenoid Assembly	-	1	-	-
13 ¹	232-118-02 ²	Solenoid Assembly	1	-	-	-
13.1	510-206-00	Nut	2	2	2	2
13.2	510-209-00	Washer	2	2	2	2
13.3	290-633-00	Solenoid Cover	1	1	1	-
13.4	455-003-00	Solenoid	1	-	1	-
13.4	455-007-00	Solenoid	-	1	-	-
13.5	420-033-00	Lockwire	1	1	1	-
13.6	510-379-00	Screw	3	3	3	3
13.7	290-634-00	Solenoid Cam	1	1	1	-
13.8	410-139-00	Electrical Connector	1	1	1	-
-	556-045-00	O-Ring	-	-	-	1
13.9	340-027-00	Diode	-	-	1	-
13.9	340-035-00	Diode	1	1	-	-
13.10	215-181-00	S/N Plate	-	1	-	-
13.10	215-191-00	S/N Plate	-	-	Opt	-
13.10	215-251-00	S/N Plate	1	-	-	-
13.10	215-294-00	S/N Plate	-	-	1	-
14	510-375-00	Bolt	1	1	1	1
15	290-913-00	Bolt	1	1	1	1
16	510-376-00	Bolt	1	1	1	1
17	290-643-00	Armor Plate – Solenoid Side	1	1	1	-
18	290-644-00	Armor Plate – Manual Side	1	1	1	-



Component Maintenance Manual

Document Number
122-005-00

Revision
36

Date
12/22/22

Page
33 of 35

Item	Part No.	Description	Quantity in 528-023-			Included in Overhaul Kit P/N 212-015-00
			01	03	51	
19	510-085-00	Washer	1	1	1	1
20 ¹	232-119-00	Manual Release Lever Assembly	1	1	1	-
20.1	290-635-00	Manual Release Lever	1	1	1	-
20.2	517-032-00	Bearing, Manual Release Lever	1	1	1	1
21	514-056-00	Spring Assembly, Cam	1	1	1	1
22 ¹	232-116-00	Side Plate Assembly, Manual	1	1	1	-
22.1	290-637-00	Side Plate, Manual	1	1	1	-
22.2	290-294-00	Bushing, Attach	1	1	1	1
22.3	517-010-00	Bearing, Load Beam Pivot	1	1	1	1
22.4	510-210-00	Helicoils	2	2	2	2
23 ¹	232-112-00	Toggle Assembly	1	1	1	-
23.1	290-638-00	Toggle	1	1	1	-
23.2	517-021-00	Bearing	4	4	4	2
23.3	290-645-00	Pin, Load Beam Roller	1	1	1	-
23.4	290-438-00	Load Beam Roller	1	1	1	-
23.5	517-037-00	Bearing, Cam Roller	1	1	1	1
23.6	290-439-00	Pin, Cam Roller	1	1	1	-
24 ¹	232-113-00	Cam Assembly	1	1	1	1
24.1	290-632-00	Cam	1	1	1	-
24.2	517-009-00	Bearing, Cam	2	2	2	-
24.3	517-031-00	Bushing, Interlock	2	2	2	-
24.4	290-603-00	Roller, Interlock	1	1	1	-
24.5	290-450-00	Pin, Interlock	1	1	1	-
24.6	514-032-00	Spring, Cam Backup	1	1	1	-
25 ¹	232-117-00	Load Beam Assembly	1	1	1	-
25.1	290-639-00	Load Beam	1	1	1	-
25.2	290-640-00	Shaft, Load Beam	1	1	1	-
26	514-031-00	Bumper, Load Beam	1	1	1	1
27 ¹	232-115-00	Side Plate Assembly- Solenoid	1	1	1	-
27.1	290-636-00	Side Plate – Solenoid	1	1	1	-
27.2	290-294-00	Attach Bushing	1	1	1	1
27.3	517-010-00	Load Beam Pivot Bearing	1	1	1	1
27.4	510-202-00	Pin	1	1	1	1
28	290-914-00	Bolt	1	1	1	1
29	510-082-00	Nut	1	1	1	1
30	290-819-00	Spring Retainer	1	1	1	-
31	510-755-00	Screw	1	1	1	1



Component Maintenance Manual

Document Number
122-005-00

Revision
36

Date
12/22/22

Page
34 of 35

Item	Part No.	Description	Quantity in 528-023-			Included in Overhaul Kit P/N 212-015-00
			01	03	51	
32	215-240-00	Rigging Warning Sticker	1	1	-	1
33 ³	215-260-00	Overhaul Label	-	-	-	1

NOTICE

¹ Item not illustrated as an assembly.

² P/N 232-118-00 was changed to 232-118-02 to replace diode P/N 340-027-00 with 340-035-00.

³ Item not shown in Figure 13.1

	Component Maintenance Manual	Document Number 122-005-00	Revision 36
		Date 12/22/22	Page 35 of 35

13.0 Instructions for Returning Equipment to the Factory

- 13.1 If an Onboard Systems product must be returned to the factory for any reason (including returns, service, repairs, overhaul, etc.) obtain an RMA number before shipping your return.

NOTICE

An RMA number is required for all equipment returns.

- To obtain an RMA, please use one of the listed methods.
 - Contact Technical Support by phone or e-mail (Techhelp@OnboardSystems.com).
 - Generate an RMA number at our website: <http://www.onboardsystems.com/rma.php>
- After you have obtained the RMA number, please be sure to:
 - Package the component carefully to ensure safe transit.
 - Write the RMA number on the outside of the box or on the mailing label.
 - Include the RMA number and reason for the return on your purchase or work order.
 - Include your name, address, phone and fax number and email (as applicable).
 - Return the components freight, cartage, insurance and customs prepaid to:

Onboard Systems International, LLC
 13915 NW 3rd Court
 Vancouver, Washington 98685
 USA
 Phone: 360-546-3072